

7 SPARE PARTS

ACCESSORIES	Q'TY
HEATING ELEMENT	2
UPPER CLOTH	2

8 SPECIFICATIONS

Model	AIE-200C	AIE-300C	AIE-205C	AIE-305C	AIE-2010
Max. Seal Length	8 inches	12 inches	8 inches	12 inches	8 inches
Max. Seal Thickness	4 mil	5 mil	6 mil	6 mil	7 mil
Seal Width	2 mm	2 mm	5 mm	5 mm	10 mm
Watts	260 W	380 W	450 W	600 W	1200 W
Weight	10 lbs	12 lbs	11 lbs	14 lbs	13 lbs



**BOATMAN
MARKING**

Packaging Supplies & Equipment

BOATMAN MARKING
2553 Lee Avenue
South El Monte, CA 91733
Phone: (626) 350-9700
Fax: (626) 350-8045

IMPULSE CUTTER-SEALER INSTRUCTION MANUAL

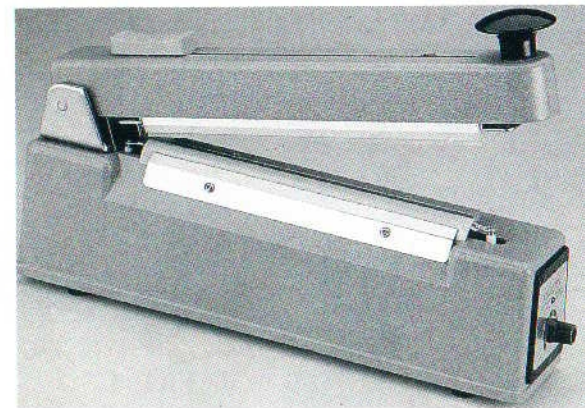

1 DESCRIPTION OF EVERY PART

- ① Handle Knob
- ② Platen Arm
- ③ Platen Spring
- ④ Platen
- ⑤ Silicon Rubber
- ⑥ Swivel
- ⑦ Hinge
- ⑧ Hinge Bracket
- ⑨ Enclosure
- ⑩ Metal Plate

- ⑪ Lower Element Teflon
- ⑫ Upper Teflon Cloth
- ⑬ Strain Relief Bushing
- ⑭ Power Supply Cord
- ⑮ Heating Element
- ⑯ Pilot Lamp
- ⑰ Timer Knob
- ⑱ Control Panel
- ⑲ Variable Resistor
- ⑳ Switch Level

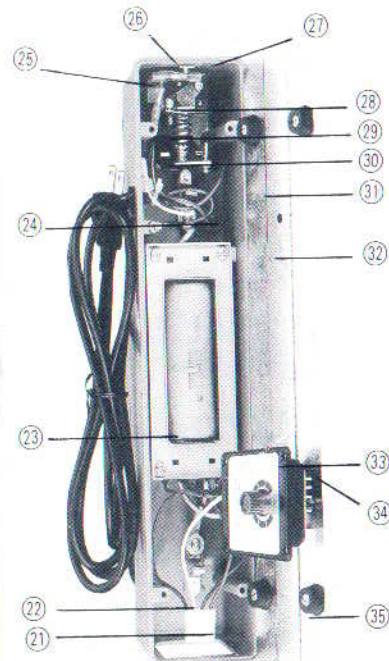
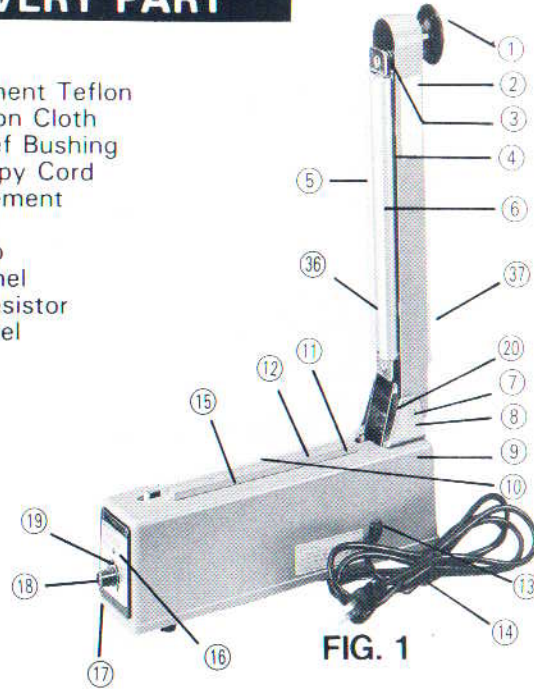

- ⑳ Wire Connector
- ㉑ Internal Wiring
- ㉒ Heater Transformer
- ㉓ Connectors
- ㉔ Microswitch
- ㉕ Switch Bracket
- ㉖ Switch Insulation
- ㉗ Switch Lever Spring
- ㉘ Switch Lever (Bottom View)
- ㉙ Heater Terminal Assembly
- ㉚ Grounding Wire
- ㉛ Cover Plate
- ㉜ Printed Wiring Board
- ㉝ Relay
- ㉞ Rubber Foot & Screw
- ㉟ Cutting Blade
- ㊱ Cutting Handle

**USE ONLY GENUINE
REPLACEMENT PARTS**

2 CONNECTION DIAGRAM

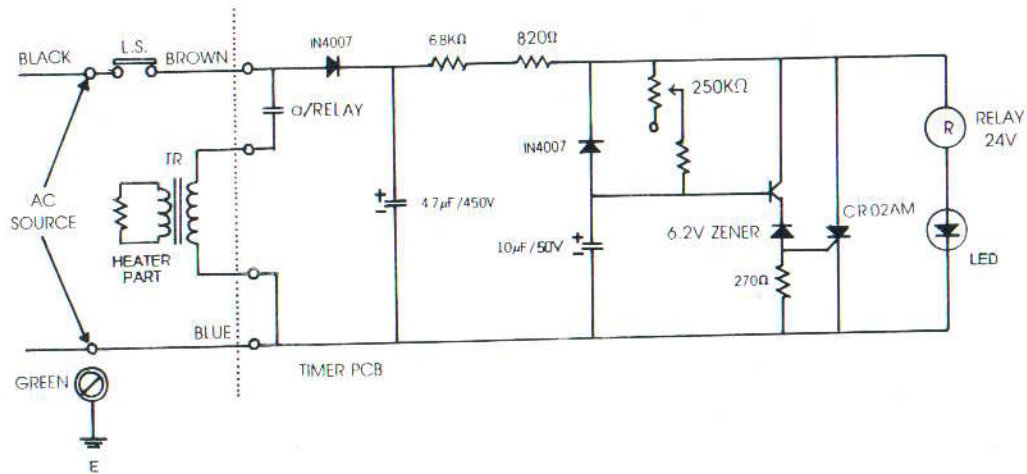

3 PURPOSE

This Impulse Sealer is to insure a water tight and air tight seal for effective packaging of tubular material, will seal and cut away excessive material 1/4" from seal.

4 CHARACTERISTIC

- Compact Design
- Strong Water Tight Seal
- Fast Operation
- Power Saving
- Precision Electric Circuitry
- Long Life

5 OPERATION

- Plug cord into AC outlet. No switch necessary. Machine will operate only when arm is depressed. Regulate the timer according to thickness of material to be sealed. Use a higher number for thicker material. Place material to be sealed, between jaws. Push handle down and keep compressed tightly until two seconds after light goes off. Sealing takes place when light is on.
- Use a lower number in case seal burns through.
- Raise to higher number when seal isn't tight.
- If the bag sticks to silicon rubber, you did not allow enough cooling time.
- Once you set the heating timer, there is no need to reset. It will remain constant and unchanged.
- No need to remove plug from socket as machine will not operate until handle is lowered. No power is consumed.

6 NOTES

- Always keep sealing platform clean. Leaving residue will reduce life of element, teflon, and silicon rubber.
- Never use moisture to clean sealing surface.
- Replace torn teflon at once. A torn cloth will short circuit the element and damage it. Every time you replace the element, replace the lower and upper teflon cloth.
- For best operation, use only genuine replacement parts.
- A worn silicon rubber will influence the seal, change the silicon when worn or burned.
- To replace cutting blade, slide cutter toward slot near handle. Lift slider up and out. Loosen screw only and remove blade with plier. Replace with new blade, tighten screw and reinsert holder as arrow on top indicates.
- Disconnect plug from electrical outlet before servicing the machine.

200C, 300C

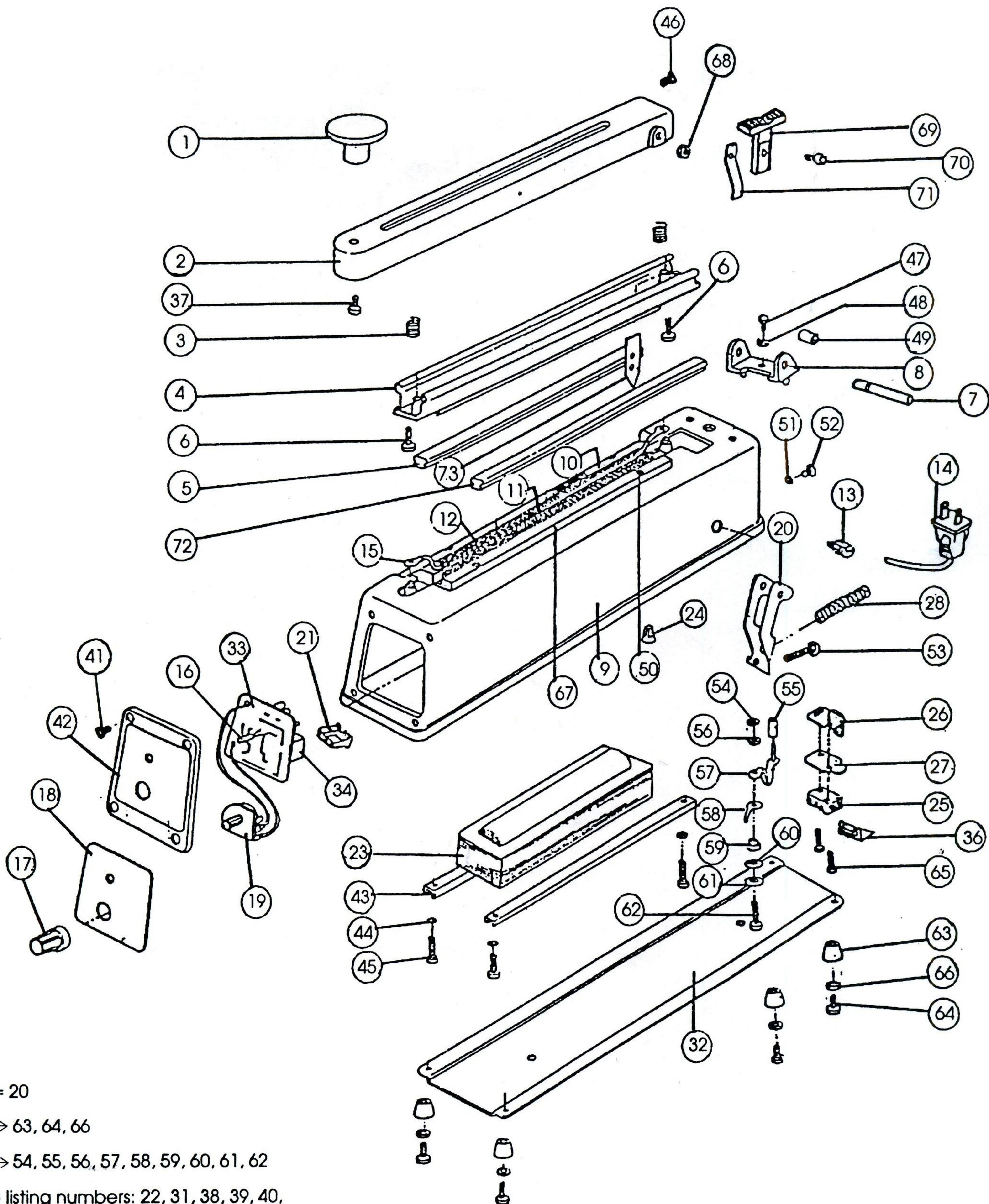

②⑨ = 20

③⑤ → 63, 64, 66

③⑩ → 54, 55, 56, 57, 58, 59, 60, 61, 62

*No listing numbers: 22, 31, 38, 39, 40,

No.	Description	Part Number	No.	Description	Part Number
1	Casting Body	*BA200C	52	Screw	
2	Casting Arm	*ARM200C	53	Screw	
3	Platen Spring	*PLATESPC	54	Washer	BELONG 30
4	Platen	*PLATE2C	55	Insulator for Bow Spring	BELONG 30
5	Silicon Rubber	*SR200C	56	Insulator Washer	BELONG 30
6	Screw	*SCREW#6C	57	Bow Spring	BELONG 30
7	Handle Pole	*PART#7	58	Brass Contact	BELONG 30
8	Hinge Bracket	*HINGE2C	59	Convex Bakelite	BELONG 30
9	Casting Body	*BD200C	60	Washer	BELONG 30
10	Side Metal Plate	*MPLATE2	61	Washer	BELONG 30
11	Lower Teflon	*TFL200C	62	Screw	BELONG 30
12	Upper Teflon	*TF200C	63	Rubber Foot	BELONG 35
13	Power Cord Holder	*CORDHOLD	64	Screw	BELONG 35
14	Cord Holder	*CORD	65	Screw	
15	Element Wire	*EF200C	66	Washer	BELONG 35
16	Led		67	Teflon Holder Bar	*TFBAR2C
17	Control Panel Knob	*KNOB	68	Nut	
18	Control Panel	*PANEL-2C	69	Blade Holder	*B-HOLDER
19	Verb Resistor	*VR250K	70	Screw	
20	Switch Lever	*LEVER2C	71	Blade Lock	
21	Connection Bush	*BUSH-H	72	Black Rubber	*SR200C
22			73	Blade	*BLADE
23	Transformer	*TR200C			
24	Connection Bush				
25	Micro Switch	*MICRO-H			
26	MS Fix Adjusting	*PART#26			
27	MS Insulating Electric Pcs	*PART#27			
28	Moving Spring	*MOVESP2C			
29	Switch Lever	*LEVER2C			
30	Bow Spring Screw Washer	*BOW-SET			
31					
32	Bottom Cover Plate	*COVER2C			
33	Timer	*TI200C			
34	Relay	*RELAY-H			
35	Rubber Foot (Include 63,64,66)	*FOOT-H2			
36	Activator	*ACTIV			
37	Screw	*SCREW#37			
38	No Listing				
39	No Listing				
40	No Listing				
41	Screw				
42	Timer Cover	*TICOVER3			
43	Timer Cover	*TRCOVER2			
44	Washer				
45	Screw				
46	Screw	*PART#46			
47	Screw				
48	Washer				
49	Fixed Shaft Liner	*PART#49			
50	Screw	*SCREW#50			
51	Washer				